























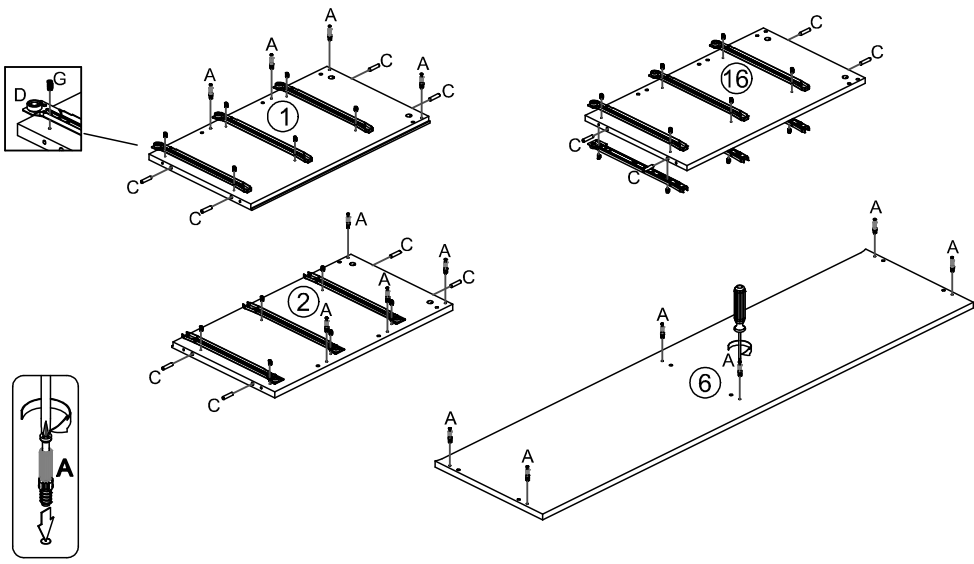

- | | | | | | |
|---|---|---|--|---|---|
| A  x26 | B  x34 | C  x44 | D  x6 | F  x54 | G ^{3,5x15}  x48 |
| J  x70 | K ^{3,5x30}  x10 | M  x4 | N  x1 | O  x12 | P  x24 |
| R  x1 | S  x4 | T  x4 | | | |

1

- A  x14
- C  x12
- D  x6
- G  3,5x16 x24



2

- B  x16
- C  x8
- S  x4
- T  x4
- N  x1

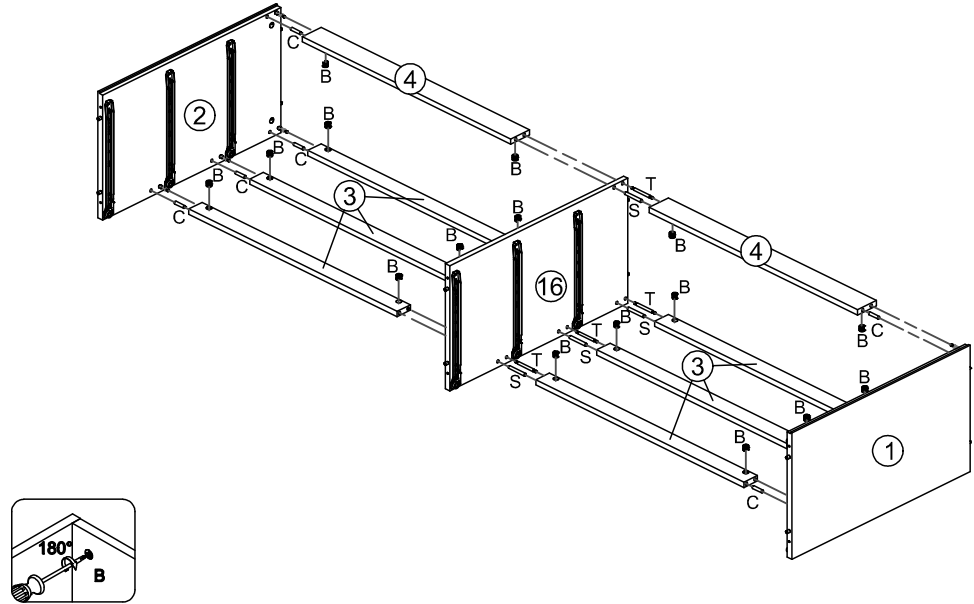



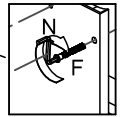
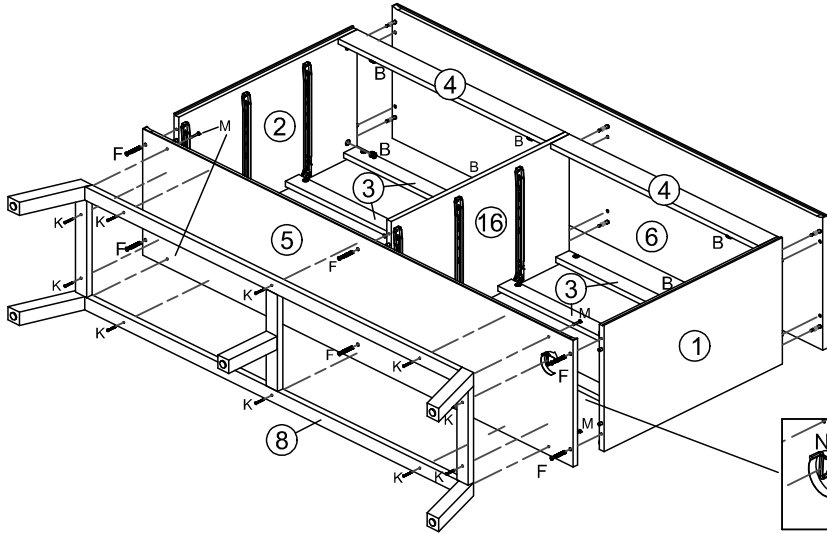
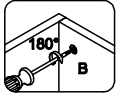
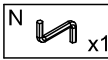
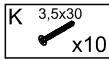
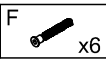



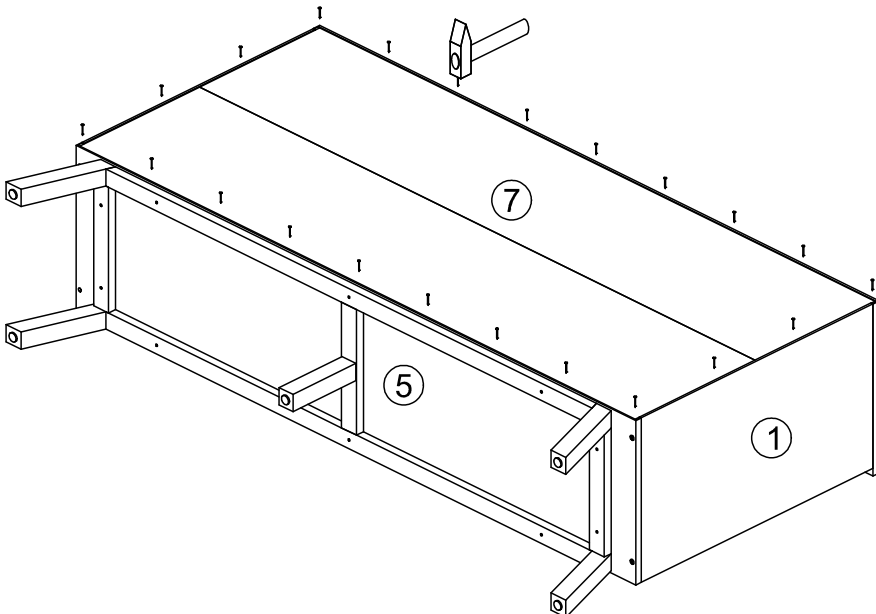
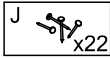



3



4



5

- A  x12
- B  x12
- C  x24
- D  x6
- F  x48
- G  x24
- J  x48
- N  x1
- O  x12
- P  x24
- S  x1

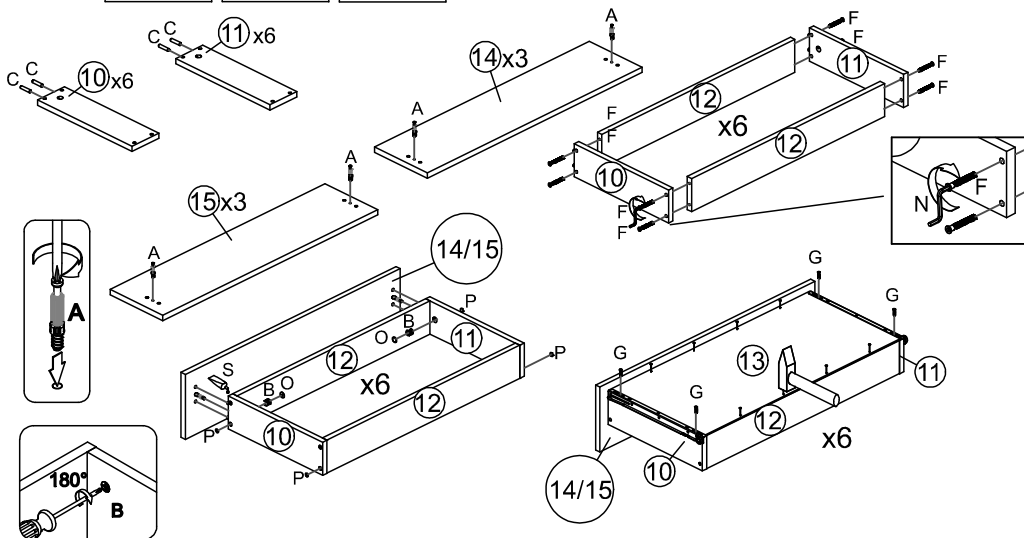

6

