

PRZED ROZPOCZĘCIEM MONTAŻU ZAPOZNAĆ SIĘ Z INSTRUKCJĄ

Narzędzia niezbędne do montażu (nie dostarczane przez producenta)

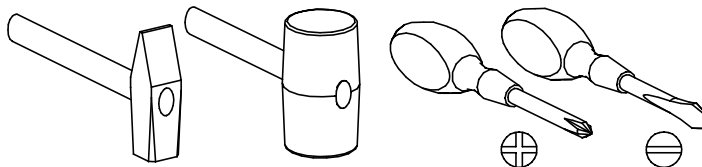

ROMERO

14P

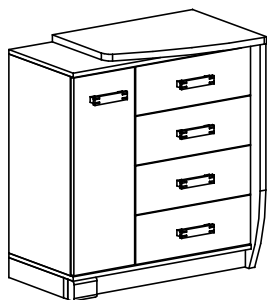

| Nr | Nazwa elementu | Dł [mm] | Szer [mm] | Gr [mm] | Ilość | Kod | Paczka |
|----|--------------------|---------|-----------|---------|-------|-----|--------|
| 1 | blat górny | 600 | 460 | 25 | 1 | | |
| 2 | przegroda pionowa | 735 | 378 | 16 | 1 | | |
| 3 | bok lewy | 735 | 381 | 16 | 1 | | |
| 4 | wieniec dolny | 774 | 400 | 16 | 1 | | |
| 5 | cokół przedni | 774 | 74 | 25 | 1 | | |
| 6 | cokół boczny | 344 | 74 | 25 | 1 | | |
| 7 | bok prawy | 841 | 455 | 25 | 1 | | |
| 8 | półka | 245 | 378 | 16 | 1 | | |
| 9 | drzwi | 729 | 265 | 16 | 1 | | |
| 10 | blat górny | 774 | 400 | 16 | 1 | | |
| 11 | front szuflady | 501 | 180 | 16 | 4 | | |
| 12 | HDF dno szuflady | 356 | 454 | 2,5 | 4 | | |
| 13 | bok szuflady lewy | 350 | 140 | 16 | 4 | | |
| 14 | bok szuflady prawy | 350 | 140 | 16 | 4 | | |
| 15 | tył szuflady | 438 | 120 | 16 | 4 | | |
| 16 | HDF ściana tylna | 755 | 515 | 2,5 | 1 | | |
| 17 | HDF ściana tylna | 755 | 264 | 2,5 | 1 | | |

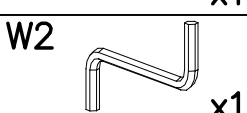
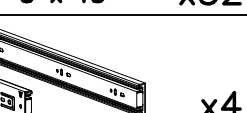
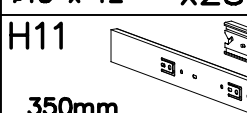
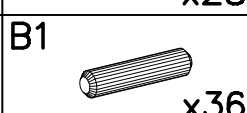
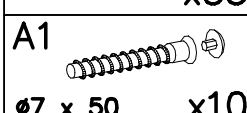
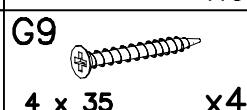
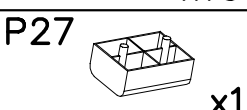
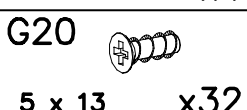
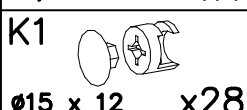
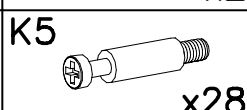
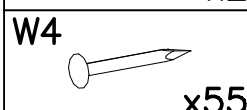
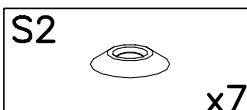
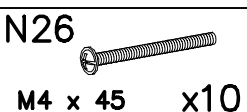
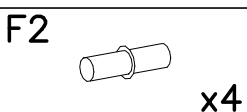
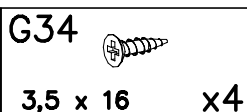
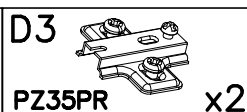
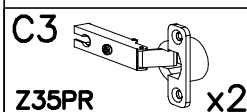
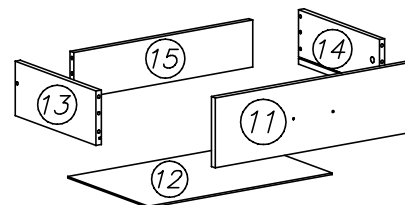
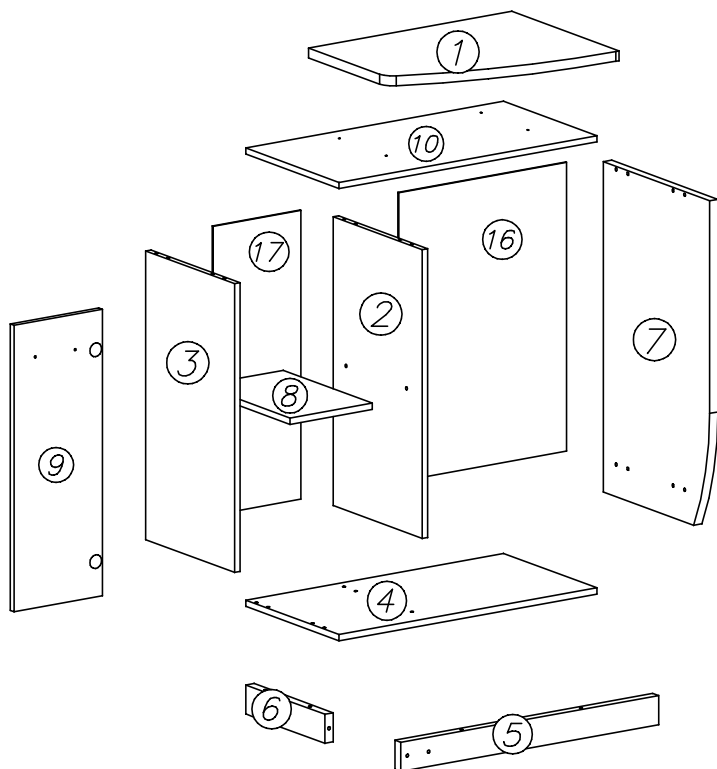

I

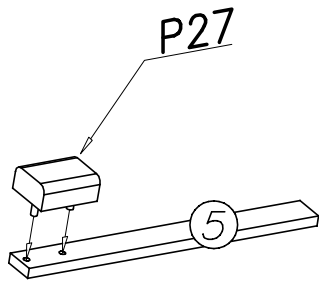

II

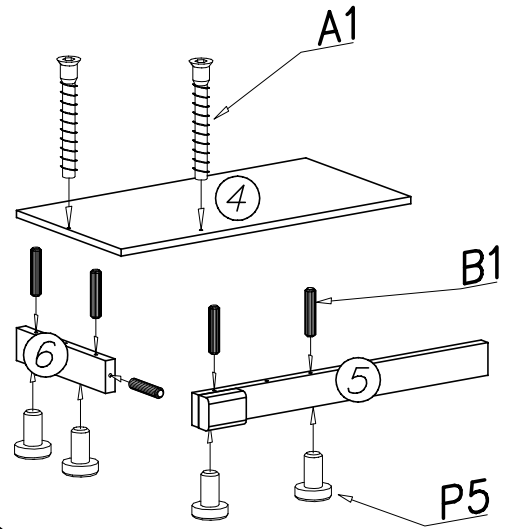

III

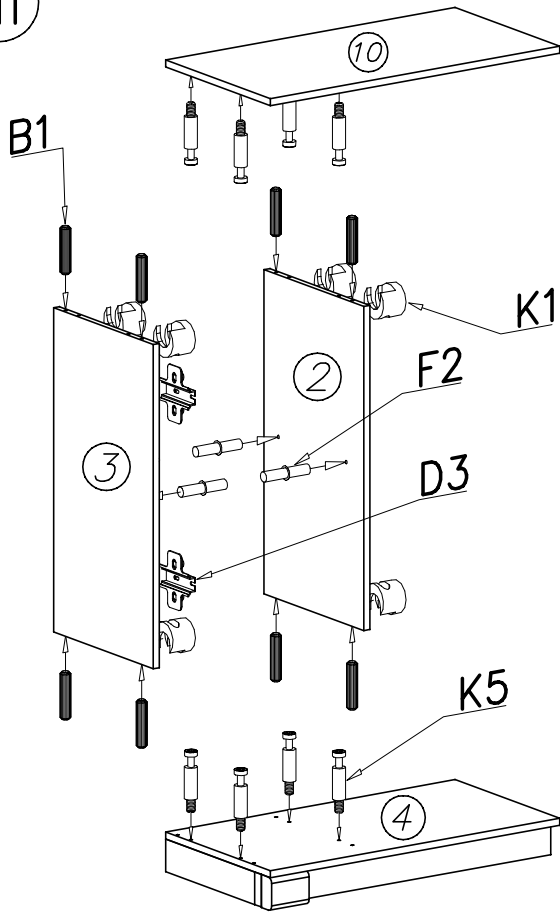

IV

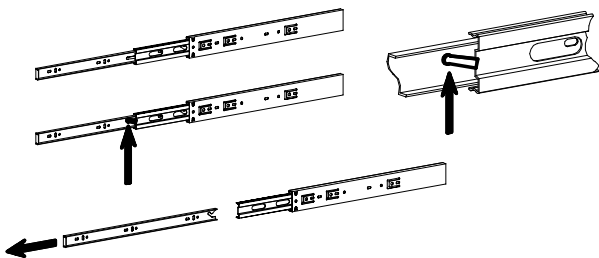
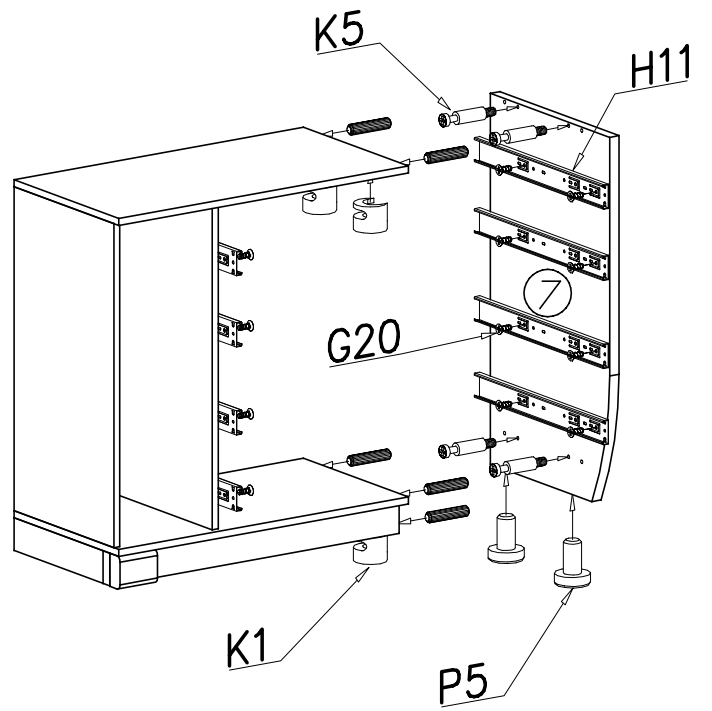

V

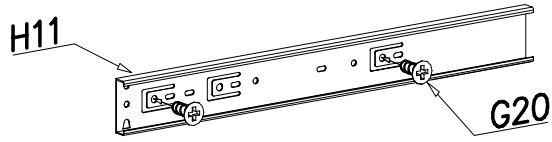
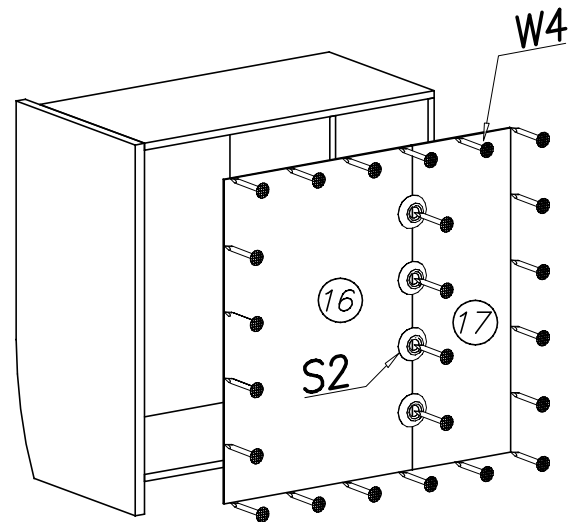

VI

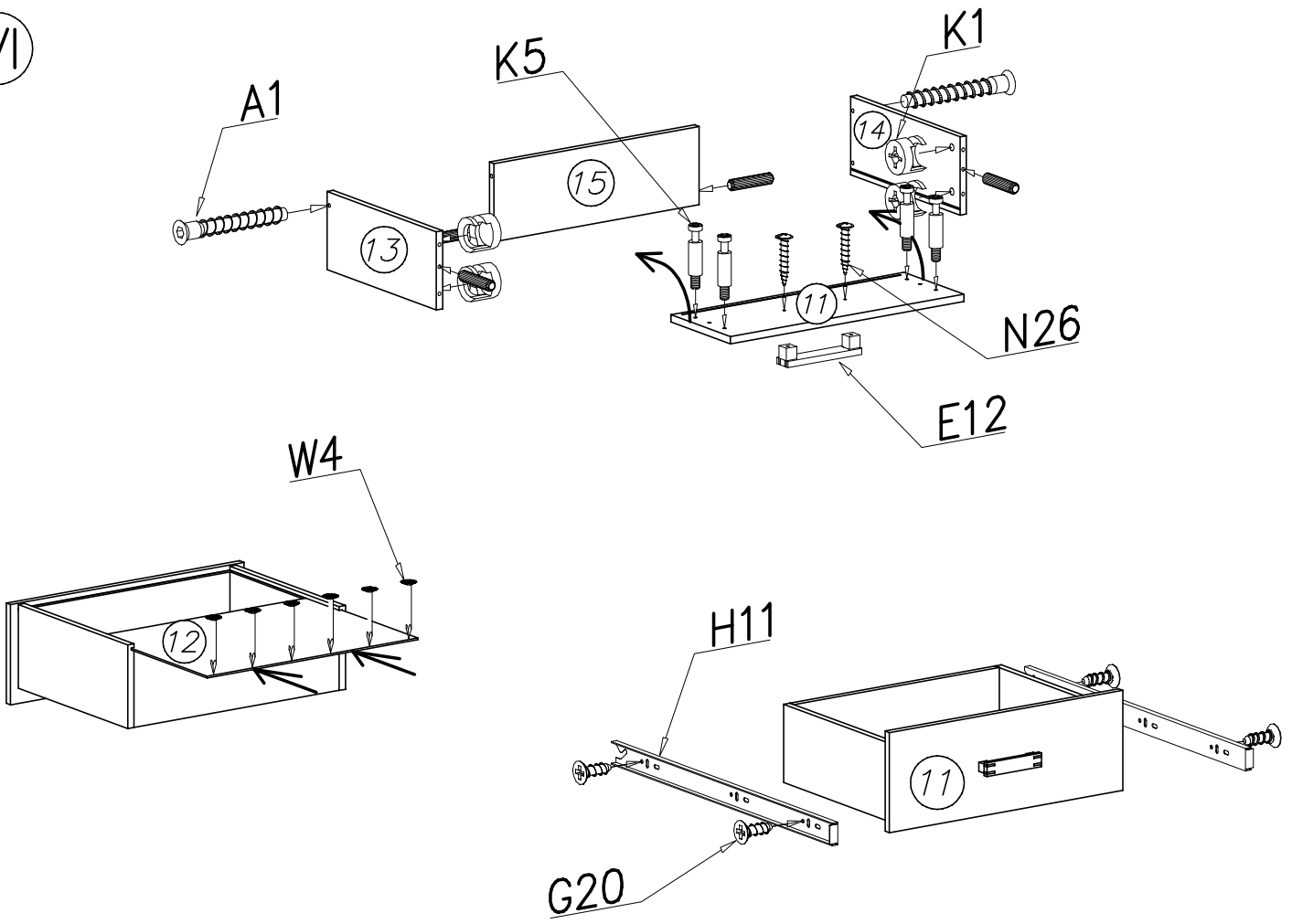

VII

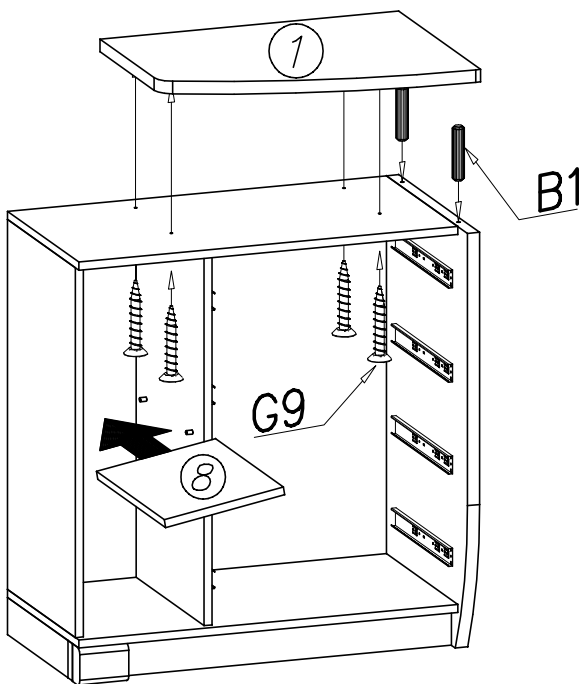

VIII

