

PRZED ROZPOCZĘCIEM MONTAŻU ZAPOZNAĆ SIĘ Z INSTRUKCJĄ

Narzędzia niezbędne do montażu (nie dostarczane przez producenta)

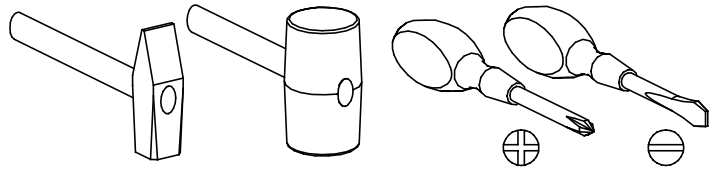
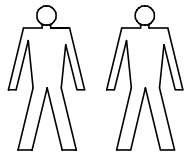

ROMERO

05

Nr	Nazwa elementu	Dł [mm]	Szer [mm]	Gr [mm]	Ilość	Kod	Paczka
1	blat górny	350	320	16	1		
2	blat dolny	350	320	16	1		
3	wieniec	317	298	16	4		
4	bok	1710	301	16	2		
5	HDF ściana tylna	1730	338	2,5	1		

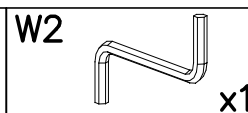
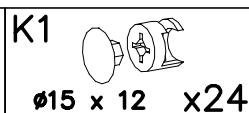
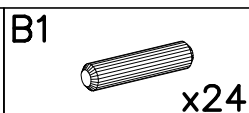
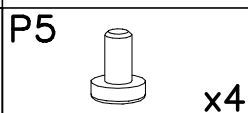
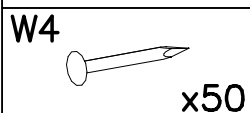
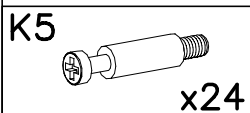
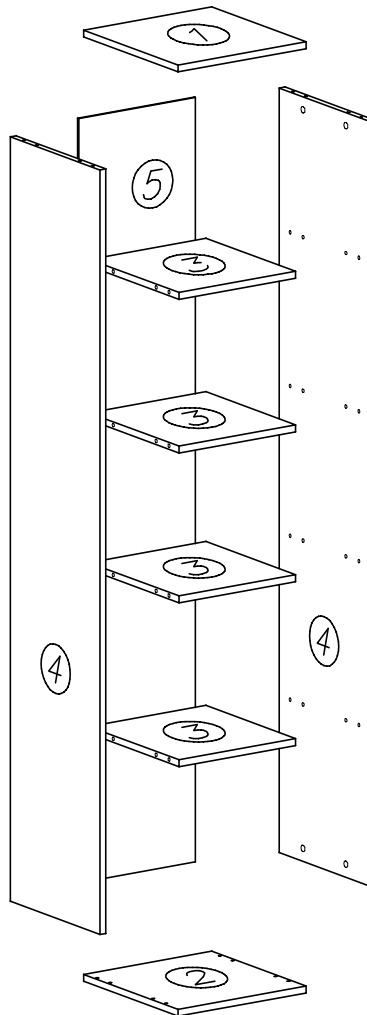
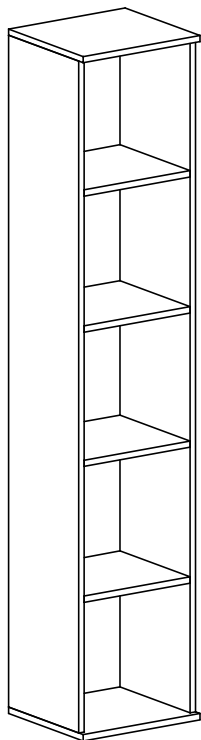

I

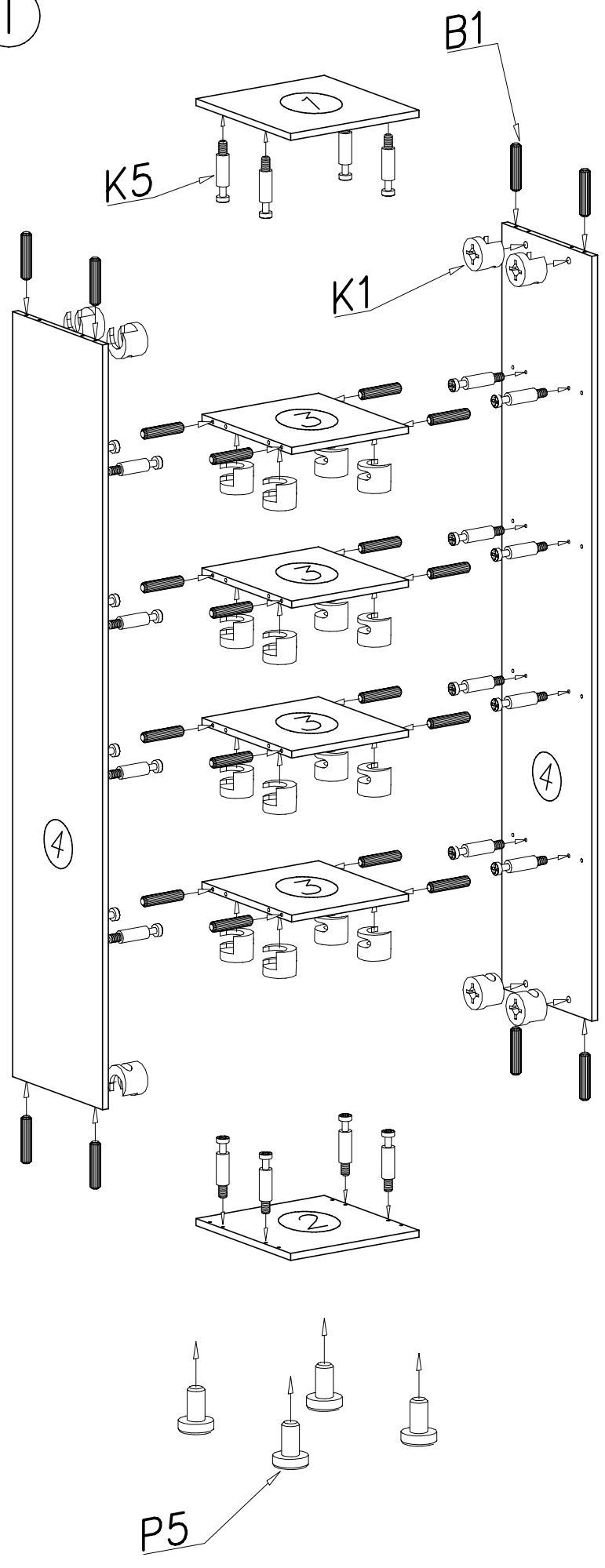

II

